

## PRODUKTINFORMATION



**HÄMTFAX**  
08-580 941 14



**FAX ON DEMAND**  
+46 8 580 941 14



**INTERNET**  
<http://www.elfa.se>

**TEKNISK INFORMATION 020-75 80 20    ORDERTEL 020-75 80 00    ORDERFAX 020-75 80 10**

**TECHNICAL INFORMATION +46 8 580 941 15    ORDERPHONE +46 8 580 941 01    ORDERFAX +46 8 580 941 11**

— Vi reserverar oss mot fel samt förbehåller oss rätten till ändringar utan föregående meddelande —

ELFA artikelnr.

73-002-39 SSM2166P Mikrofonförst.

73-002-47 SSM2166S Mikrofonförst. (Y)

Antal sidor: 16

### FEATURES

- Complete Microphone Conditioner in a 14-Pin Package
- Single +5 V Operation
- Adjustable Noise Gate Threshold
- Compression Ratio Set by External Resistor
- Automatic Limiting Feature—Prevents ADC Overload
- Adjustable Release Time
- Low Noise and Distortion
- Power-Down Feature
- 20 kHz Bandwidth ( $\pm 1$  dB)
- Low Cost

### APPLICATIONS

- Microphone Preamplifier/Processor
- Computer Sound Cards
- Public Address/Paging Systems
- Communication Headsets
- Telephone Conferencing
- Guitar Sustain Effects Generator
- Computerized Voice Recognition
- Surveillance Systems
- Karaoke and DJ Mixers

### GENERAL DESCRIPTION

The SSM2166 integrates a complete and flexible solution for conditioning microphone inputs in computer audio systems. It is also excellent for improving vocal clarity in communications and public address systems. A low noise voltage controlled amplifier (VCA) provides a gain that is dynamically adjusted by a control loop to maintain a set compression characteristic. The compression ratio is set by a single resistor and can be varied from 1:1 to over 15:1 relative to a user defined "rotation point;" signals above the rotation point are limited to prevent overload and eliminate "popping." In the 1:1 compression setting the SSM2166 can be programmed with a fixed gain of up to

20 dB; this gain is in addition to the variable gain in other compression settings. The input buffer can also be configured for front-end gains of 0 dB to 20 dB. A downward expander (noise gate) prevents amplification of noise or hum. This results in optimized signal levels prior to digitization, thereby eliminating the need for additional gain or attenuation in the digital domain that could add noise or impair accuracy of speech recognition algorithms. The compression ratio and time constants are set externally. A high degree of flexibility is provided by the VCA Gain, Rotation Point, and Noise Gate adjustment pins.

The SSM2166 is an ideal companion product for audio codecs used in computer systems, such as the AD1845 and AD1847. The device is available in 14-pin SOIC and P-DIP packages, and guaranteed for operation over the extended industrial temperature range of  $-40^{\circ}\text{C}$  to  $+85^{\circ}\text{C}$ . For similar features/performance in an 8-pin package, please refer to the SSM2165.

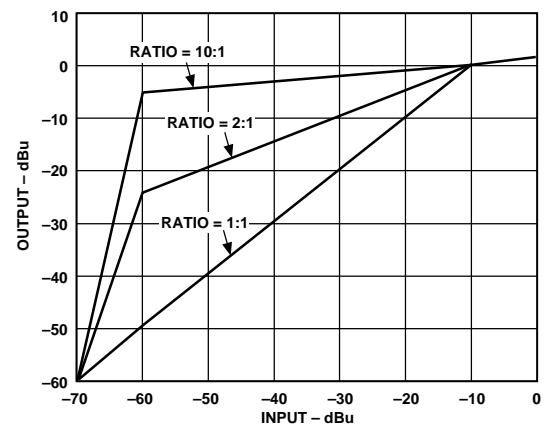

Figure 1. SSM2166 Compression and Gating Characteristics with 10 dB of Fixed Gain (The Gain Adjust Pin Can Be Used to Vary This Fixed Gain Amount)

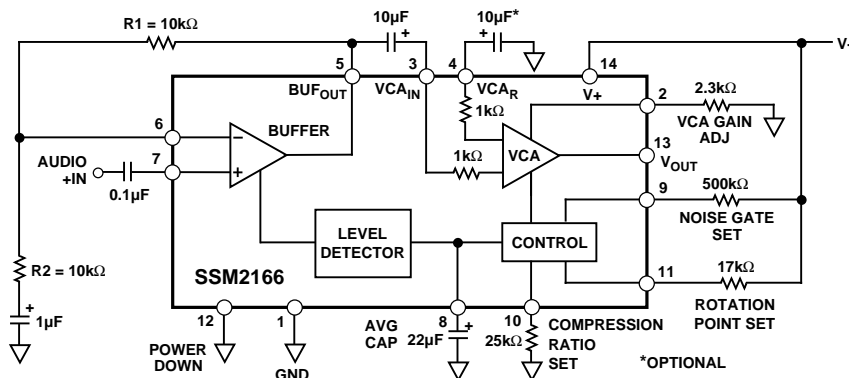

Figure 2. Functional Block Diagram and Typical Speech Application

\*Patents pending.

REV. 0

Information furnished by Analog Devices is believed to be accurate and reliable. However, no responsibility is assumed by Analog Devices for its use, nor for any infringements of patents or other rights of third parties which may result from its use. No license is granted by implication or otherwise under any patent or patent rights of Analog Devices.

# SSM2166–SPECIFICATIONS ( $V_+ = +5\text{ V}$ , $f = 1\text{ kHz}$ , $R_L = 100\text{ k}\Omega$ , $R_{\text{GATE}} = 600\text{ k}\Omega$ , $R_{\text{ROTATION}} = 3\text{ k}\Omega$ , $R_{\text{COMP}} = 0\text{ }\Omega$ , $R_1 = 0\text{ }\Omega$ , $R_2 = \infty\text{ }\Omega$ , $T_A = +25^\circ\text{C}$ , unless otherwise noted, $V_{\text{IN}} = 300\text{ mV rms}$ .)

Parameter	Symbol	Conditions	Min	Typ	Max	Units
<b>AUDIO SIGNAL PATH</b>						
Voltage Noise Density	$e_n$	15:1 Compression 20 kHz Bandwidth, $V_{\text{IN}} = \text{GND}$		17		$\text{nV}/\sqrt{\text{Hz}}$
Noise				-109		$\text{dBu}^1$
Total Harmonic Distortion	THD+N	2nd & 3rd Harmonics, $V_{\text{IN}} = -20\text{ dBu}$ 22 kHz Low-Pass Filter		0.25	0.5	%
Input Impedance	$Z_{\text{IN}}$			180		$\text{k}\Omega$
Output Impedance	$Z_{\text{OUT}}$			75		$\Omega$
Load Drive		Resistive	5			$\text{k}\Omega$
		Capacitive			2	$\text{nF}$
Buffer						
Input Voltage Range		1% THD		1		V rms
Output Voltage Range		1% THD		1		V rms
VCA						
Input Voltage Range		1% THD		1		V rms
Output Voltage Range		1% THD		1.4		V rms
Gain Bandwidth Product		1:1 Compression, VCA G = 60 dB		30		MHz
<b>CONTROL SECTION</b>						
VCA Dynamic Gain Range				60		dB
VCA Fixed Gain Range				-60 to +19		dB
Compression Ratio, Min				1:1		
Compression Ratio, Max		See Figure 5 for $R_{\text{COMP}}/R_{\text{ROT}}$		15:1		
Control Feedthrough		15:1 Compression, Rotation Point = -10 dBu		$\pm 5$		mV
<b>POWER SUPPLY</b>						
Supply Voltage Range	$V_S$		4.5		5.5	V
Supply Current	$I_{\text{SY}}$			7.5	10	mA
Quiescent Output Voltage Level				2.2		V
Power Supply Rejection Ratio	PSRR			50		dB
<b>POWER DOWN</b>						
Supply Current		Pin 12 = $V_+$ <sup>2</sup>		10	100	$\mu\text{A}$

## NOTES

<sup>1</sup>0 dBu = 0.775 V rms.

<sup>2</sup>Normal operation: Pin 12 = 0 V.

Specifications subject to change without notice.

## ABSOLUTE MAXIMUM RATINGS

Supply Voltage	+10 V
Audio Input Voltage	Supply Voltage
Operating Temperature Range	-40°C to +85°C
Storage Temperature Range	-65°C to +150°C
Junction Temperature ( $T_J$ )	+150°C
Lead Temperature (Soldering, 60 sec)	+300°C

## ESD RATINGS

883 (Human Body) Model	2.0 kV
------------------------	--------

## THERMAL CHARACTERISTICS

### Thermal Resistance

#### 14-Pin Plastic DIP

$\theta_{\text{JA}}$  ..... 83°C/W

$\theta_{\text{JC}}$  ..... 39°C/W

#### 14-Pin SOIC

$\theta_{\text{JA}}$  ..... 120°C/W

$\theta_{\text{JC}}$  ..... 36°C/W

## CAUTION

ESD (electrostatic discharge) sensitive device. Electrostatic charges as high as 4000 V readily accumulate on the human body and test equipment and can discharge without detection. Although the SSM2166 features proprietary ESD protection circuitry, permanent damage may occur on devices subjected to high energy electrostatic discharges. Therefore, proper ESD precautions are recommended to avoid performance degradation or loss of functionality.

## ORDERING GUIDE

Model	Temperature Range	Package Description	Package Option
SSM2166P	-40°C to +85°C	Plastic DIP	N-14
SSM2166S	-40°C to +85°C	Narrow SOIC	SO-14



## PIN DESCRIPTION

Pin #	Mnemonic	Function
1	GND	Ground
2	GAIN ADJUST	VCA Gain Adjust Pin. A resistor from this pin to ground sets the fixed gain of the VCA. To check the setting of this pin the compression pin (Pin 10) should be grounded for no compression. The gain can be varied from 0 dB to 20 dB. For 20 dB leave the pin open. For 0 dB of fixed gain, a typical resistor value is approximately 1 k $\Omega$ . For 10 dB of fixed gain, the resistor value is approximately 2 k $\Omega$ –3 k $\Omega$ . For resistor values < 1 k $\Omega$ , the VCA can attenuate or mute. Refer to Figure 6.
3	VCA <sub>IN</sub>	VCA Input Pin. A typical connection is a 10 $\mu$ F capacitor from the buffer output pin (Pin 5) to this pin.
4	VCA <sub>R</sub>	Inverting Input to the VCA. This input can be used as a nonground reference for the audio input signal (see application notes).
5	BUF OUT	Input Buffer Amplifier Output Pin. Must not be loaded by capacitance to ground.
6	-IN	Inverting Input to the Buffer. A 10 k $\Omega$ feedback resistor R1 from the buffer output Pin 5 to this input pin, and a resistor R2, from this pin through a 1 $\mu$ F to ground gives gains of 6 dB to 20 dB for R2 = 10 k $\Omega$ to 1.1 k $\Omega$ .
7	AUDIO +IN	Input Audio Signal. The input signal should be ac-coupled (0.1 $\mu$ F typical) into this pin.
8	AVG CAP	Detector Averaging Capacitor. A capacitor, 2.2 $\mu$ F–22 $\mu$ F, to ground from this pin is the averaging capacitor for the detector circuit.
9	NOISE GATE SET	Noise Gate Threshold Set Point. A resistor to V+ sets the level below which input signals are downward-expanded. For a 0.7 mV threshold, the resistor value is approximately 380 k $\Omega$ . Increasing the resistor value reduces the threshold. See Figure 4.
10	COMP RATIO SET	Compression Ratio Set Pin. A resistor to ground from this pin sets the compression ratio as shown in Figure 1. Figure 5 gives resistor values for various rotation points.
11	ROTATION SET	Rotation Point Set Pin. This is set by a resistor to the positive supply. This resistor together with the gain adjust pin determines the onset of limiting. A typical value for this resistor is 17K for a 100 mV “rotation point.” Increasing the resistor value reduces the level at which limiting occurs. Refer to Figure 9.
12	POWER DOWN	Power-Down Pin. Connect to ground for normal operation. Connect to positive supply for power-down mode.
13	OUTPUT	Output Signal.
14	V+	Positive Supply, +5 V Nominal.

## PIN CONFIGURATION

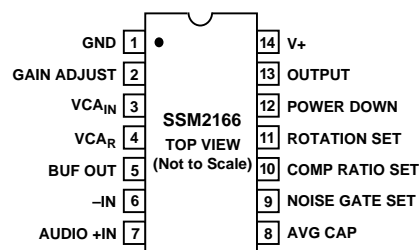

# SSM2166

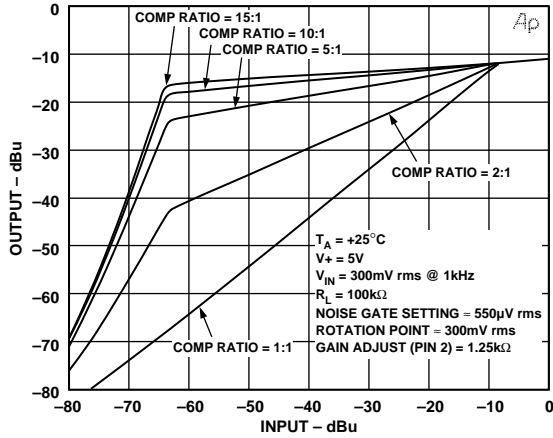

Figure 3. Output vs. Input Characteristics

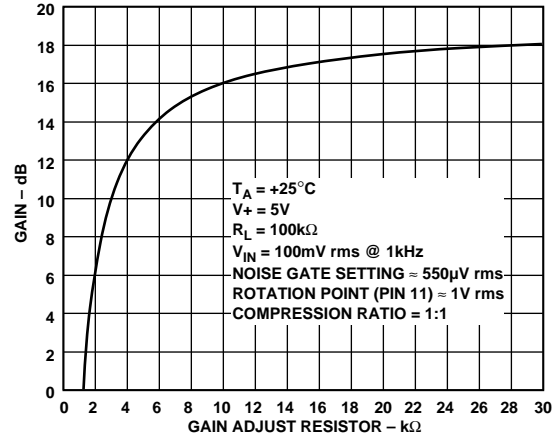

Figure 6. VCA Gain vs.  $R_{GAIN}$  (Pin 2 to GND)

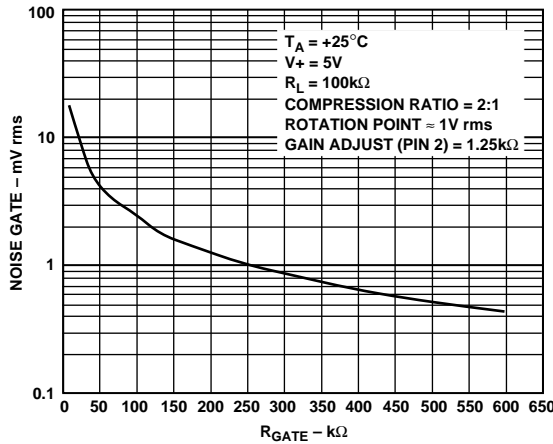

Figure 4. Noise Gate vs.  $R_{GATE}$  (Pin 9 to  $V_+$ )

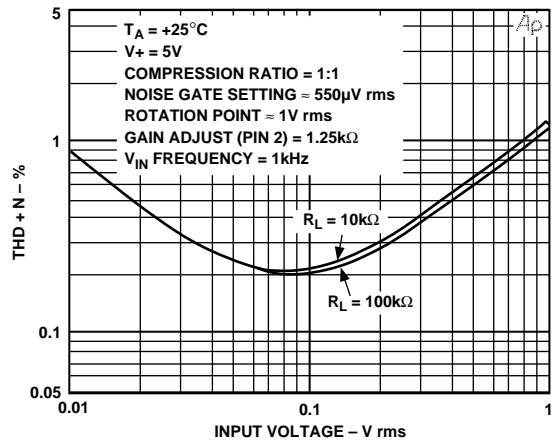

Figure 7. THD+N (%) vs. Input (V rms)

ROTATION POINT	COMPRESSION RATIO				
	1:1	2:1	5:1	10:1	15:1
100mV rms	0 $\Omega$	23	43	64	80
300mV rms	0 $\Omega$	17	28	40	49
1V rms	0 $\Omega$	12	19	27	32

$R_{COMP}$  -  $k\Omega$ , TYPICAL

Figure 5. Compression Ratio vs.  $R_{COMP}$  (Pin 10 to GND)

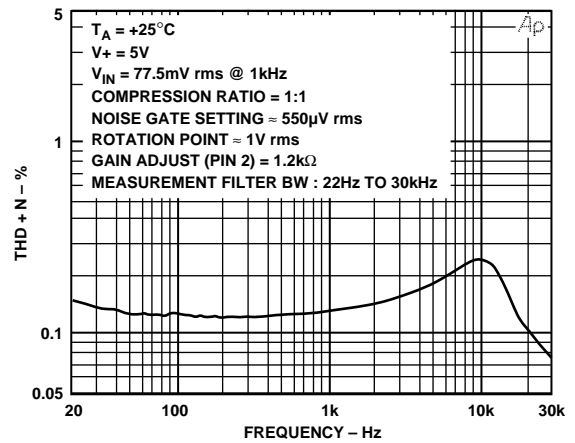

Figure 8. THD+N (%) vs. Frequency (Hz)

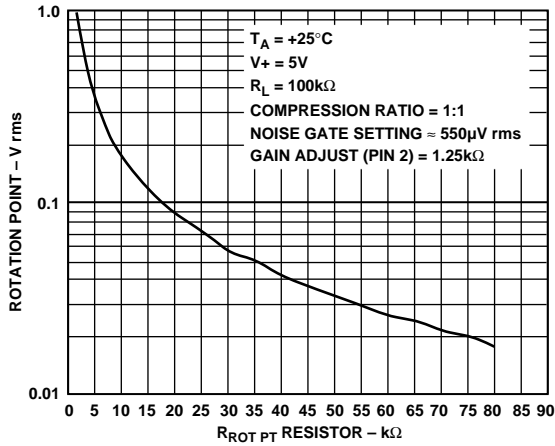

Figure 9. Rotation Point vs. R<sub>ROT PT</sub> (Pin 11 to V<sub>+</sub>)

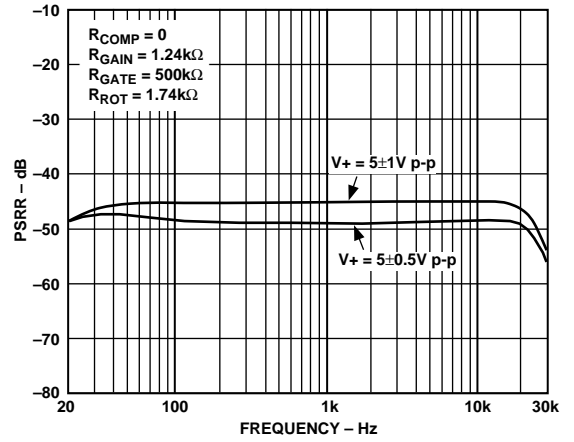

Figure 10c. PSRR vs. Frequency

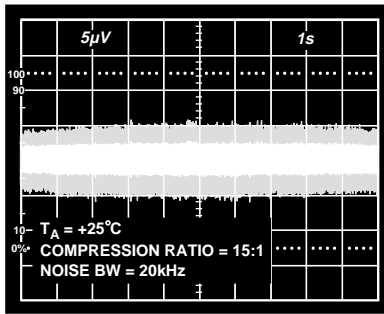

Figure 10a. Wideband Output Noise

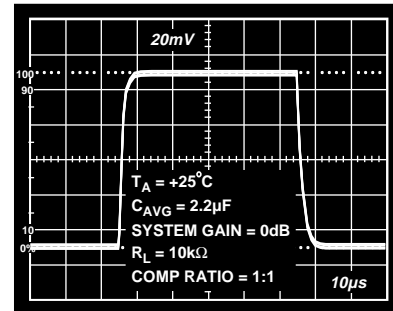

Figure 11. Small Signal Transient Response

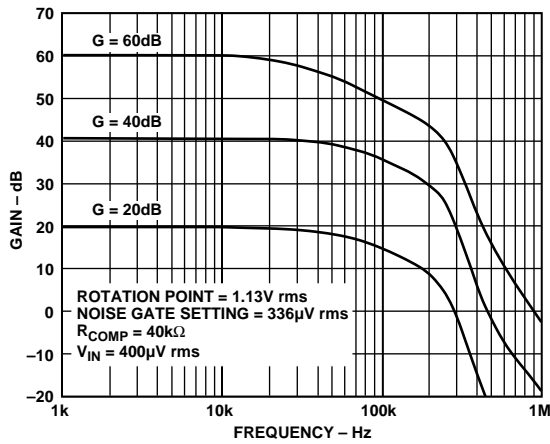

Figure 10b. GBW Curves vs. VCA Gain

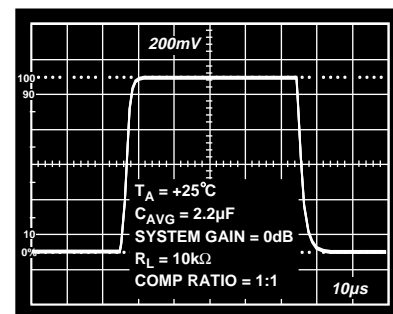

Figure 12. Large Signal Transient Response

# SSM2166

## APPLICATIONS INFORMATION

The SSM2166 is a complete microphone signal conditioning system on a single integrated circuit. Designed primarily for voiceband applications, this integrated circuit provides amplification, rms detection, limiting, variable compression, and downward expansion. An integral voltage-controlled amplifier (VCA) provides up to 60 dB of gain in the signal path with approximately 30 kHz bandwidth. Additional gain is provided by an input buffer op amp circuit that can be set anywhere from 0 dB to 20 dB, for a total signal path gain of up to 80 dB. The device operates on a single +5 V supply, accepts input signals up to 1 V rms, and produces output signal levels > 1 V rms (3 V p-p) into loads > 5 k $\Omega$ . The internal rms detector has a time constant set by an external capacitor.

The SSM2166 contains an input buffer and automatic gain control (AGC) circuit for audio- and voiceband signals. Circuit operation is optimized by providing a user-adjustable time constant and compression ratio. A downward expansion (noise gating) feature eliminates circuit noise in the absence of an input signal. The SSM2166 allows the user to set the downward expansion threshold, the limiting threshold (rotation point), input buffer fixed gain, and the internal VCA's nominal gain at the rotation point. The SSM2166 also features a power-down mode and muting capability.

### Theory of Operation

Figure 13 illustrates a typical transfer characteristic for the SSM2166 where the output level in dB is plotted as a function of the input level in dB. The dotted line indicates the transfer characteristic for a unity-gain amplifier. For input signals in the range of  $V_{DE}$  (Downward Expansion) to  $V_{RP}$  (Rotation Point) an "r" dB change in the input level causes a 1 dB change in the output level. Here, "r" is defined as the "compression ratio." The compression ratio may be varied from 1:1 (no compression) to over 15:1 via a single resistor,  $R_{COMP}$ . Input signals above  $V_{RP}$  are compressed with a fixed compression ratio of approximately 15:1. This region of operation is the "limiting region." Varying the compression ratio has no effect on the limiting region. The breakpoint between the compression region and the limiting region is referred to as the "limiting threshold" or the "rotation point," and is user-specified in the SSM2166. The term "rotation point" derives from the observation that the straight line in the compression region "rotates" about this point on the input/output characteristic as the compression ratio is changed.

The gain of the system with an input signal level of  $V_{RP}$  is fixed by  $R_{GAIN}$  regardless of the compression ratio, and is the "nominal gain" of the system. The nominal gain of the system may be increased by the user via the onboard VCA by up to 20 dB. Additionally, the input buffer of the SSM2166 can be configured to provide fixed gains of 0 dB to 20 dB with  $R1$  and  $R2$ .

Input signals below  $V_{DE}$  are downward expanded; that is, a -1 dB change in the input signal level causes approximately a -3 dB change in the output level. As a result, the gain of the system is small for very small input signal levels, even though it may be quite large for small input signals above of  $V_{DE}$ . The downward expansion threshold,  $V_{DE}$ , is set externally by the user via  $R_{GATE}$  at Pin 9 (NOISE GATE). Finally, the SSM2166 provides an active HIGH, CMOS-compatible digital input whereby a power-down feature will reduce device supply current to less than 100  $\mu$ A.

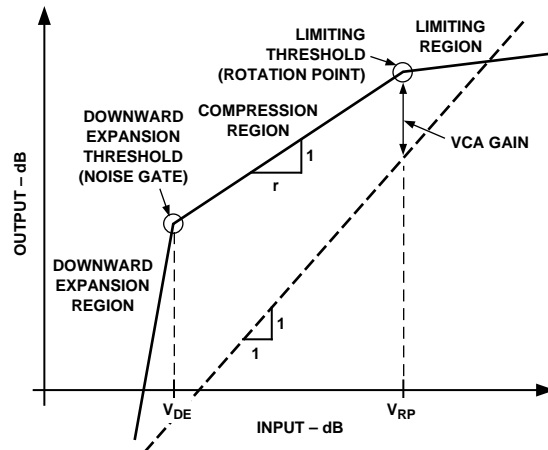

Figure 13. General Input/Output Characteristics of the SSM2166

### The SSM2166 Signal Path

Figure 14 illustrates the block diagram of the SSM2166. The audio input signal is processed by the input buffer and then by the VCA. The input buffer presents an input impedance of approximately 180 k $\Omega$  to the source. A dc voltage of approximately 1.5 V is present at AUDIO +IN (Pin 7 of the SSM2166), requiring the use of a blocking capacitor ( $C1$ ) for ground-referenced sources. A 0.1  $\mu$ F capacitor is a good choice for most audio applications. The input buffer is a unity-gain stable amplifier that can drive the low impedance input of the VCA.

The VCA is a low distortion, variable-gain amplifier whose gain is set by the side-chain control circuitry. The input to the VCA is a virtual ground in series with approximately 1 k $\Omega$ . An external blocking capacitor ( $C6$ ) must be used between the buffer's output and the VCA input. The 1 k $\Omega$  impedance between amplifiers determines the value of this capacitor which is typically between 4.7  $\mu$ F and 10  $\mu$ F. An aluminum electrolytic capacitor is an economical choice. The VCA amplifies the input signal current flowing through  $C6$  and converts this current to a voltage at the SSM2166's output pin (Pin 13). The net gain from input to output can be as high as 60 dB (without additional buffer gain), depending on the gain set by the control circuitry.

The gain of the VCA at the rotation point is set by the value of a resistor connected between Pin 2 and GND,  $R_{GAIN}$ . The relationship between the VCA gain and  $R_{GAIN}$  is shown in Figure 6. The AGC range of the SSM2166 can be as high as 60 dB. The  $VCA_{IN}$  pin (Pin 3) on the SSM2166 is the noninverting input terminal to the VCA. The inverting input of the VCA is also available on the SSM2166's Pin 4 ( $VCA_R$ ) and exhibits an input impedance of 1 k $\Omega$ , as well. As a result, this pin can be used for differential inputs or for the elimination of grounding problems by connecting a capacitor whose value equals that used in series with the  $VCA_{IN}$  pin, to ground. See Figure 22, SSM2166 Evaluation Board for more details.

The output impedance of the SSM2166 is typically less than 75  $\Omega$ , and the external load on Pin 13 should be >5 k $\Omega$ . The nominal output dc voltage of the device is approximately 2.2 V. Use a blocking capacitor for grounded loads.

The bandwidth of the SSM2166 is quite wide at all gain settings. The upper 3 dB point is approximately 30 kHz at gains as high as 60 dB (using the input buffer for additional gain, circuit

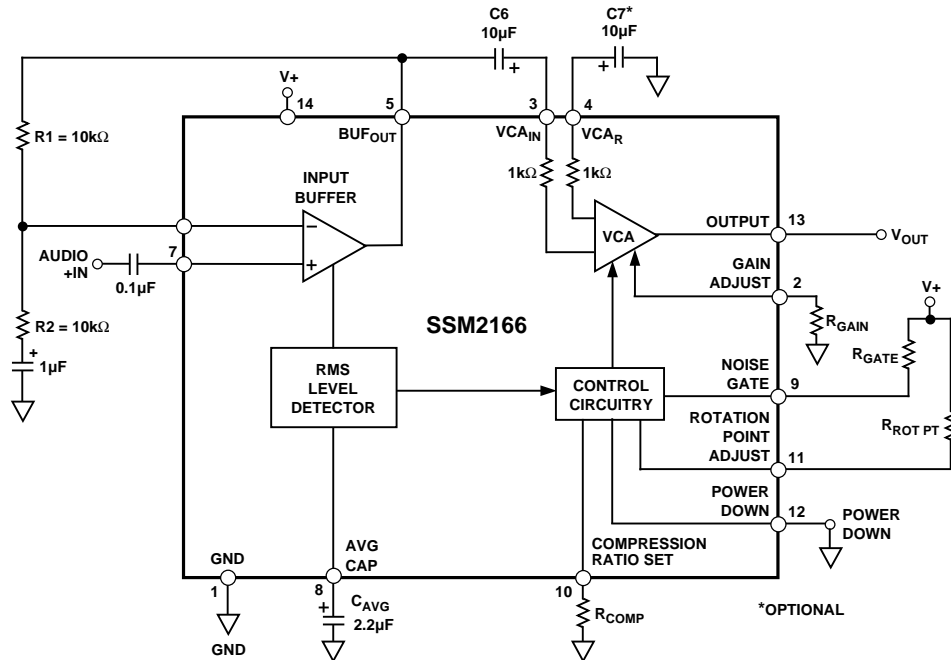

Figure 14. Functional Block Diagram and Typical Application

bandwidth is unaffected). The GBW plots are shown in Figure 10b. The lower 3 dB cutoff frequency of the SSM2166 is set by the input impedance of the VCA (1 k $\Omega$ ) and C6. While the noise of the input buffer is fixed, the input referred noise of the VCA is a function of gain. The VCA input noise is designed to be a minimum when the gain is at a maximum, thereby optimizing the usable dynamic range of the part. A photograph of the SSM2166's wideband peak-to-peak output noise is illustrated in Figure 10b.

#### The Level Detector

The SSM2166 incorporates a full-wave rectifier and a patent-pending, true rms level detector circuit whose averaging time constant is set by an external capacitor connected to the AVG CAP pin (Pin 8). For optimal low frequency operation of the level detector down to 10 Hz, the value of the capacitor should be 2.2  $\mu$ F. Some experimentation with larger values for the AVG CAP may be necessary to reduce the effects of excessive low frequency ambient background noise. The value of the averaging capacitor affects sound quality: too small a value for this capacitor may cause a "pumping effect" for some signals, while too large a value can result in slow response times to signal dynamics. Electrolytic capacitors are recommended here for lowest cost and should be in the range of 2  $\mu$ F to 47  $\mu$ F. Capacitor values from 18  $\mu$ F to 22  $\mu$ F have been found to be more appropriate in voiceband applications, where capacitors on the low end of the range seem more appropriate for music program material.

The rms detector filter time constant is approximately given by  $10 \cdot C_{AVG}$  milliseconds where  $C_{AVG}$  is in  $\mu$ F. This time constant controls both the steady-state averaging in the rms detector as well as the release time for compression; that is, the time it takes for the system gain to react when a large input is followed by a

small signal. The attack time, the time it takes for the gain to be reduced when a small signal is followed by a large signal, is controlled partly by the AVG CAP value, but is mainly controlled by internal circuitry that speeds up the attack for large level changes. This limits overload time to under 1 ms in most cases.

The performance of the rms level detector is illustrated in Figure 15 for a  $C_{AVG}$  of 2.2  $\mu$ F (Figure 15a) and 22  $\mu$ F (Figure 15b). In each of these photographs, the input signal to the SSM2166 (not shown) is a series of tone bursts in 6 successive 10 dB steps. The tone bursts range from -66 dBV (0.5 mV rms) to -6 dBV (0.5 V rms). As illustrated in the photographs, the attack time of the rms level detector is dependent only on  $C_{AVG}$ , but the release times are linear ramps whose decay times are dependent on both  $C_{AVG}$  and the input signal step size. The rate of release is approximately 240 dB/s for a  $C_{AVG}$  of 2.2  $\mu$ F, and 12 dB/s for a  $C_{AVG}$  of 22  $\mu$ F.

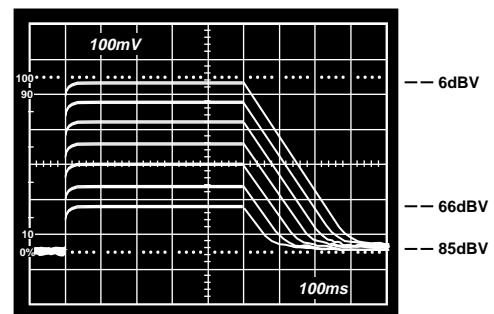

Figure 15a. RMS Level Detector Performance with  $C_{AVG} = 2.2 \mu F$

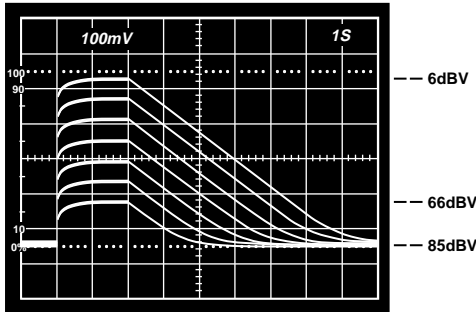

Figure 15b. RMS Level Detector Performance with  $C_{AVG} = 22 \mu F$

**Control Circuitry**

The output of the rms level detector is a signal proportional to the log of the true rms value of the buffer output with an added dc offset. The control circuitry subtracts a dc voltage from this signal, scales it, and sends the result to the VCA to control the gain. The VCA's gain control is logarithmic—a linear change in control signal causes a dB change in gain. It is this control law that allows linear processing of the log rms signal to provide the flat compression characteristic on the input/output characteristic shown in Figure 13.

**Compression Ratio.** Changing the scaling of the control signal fed to the VCA causes a change in the circuit's compression ratio, "r." This effect is shown in Figure 16. The compression ratio can be set by connecting a resistor between the COMP RATIO pin (Pin 10) and GND. Lowering  $R_{COMP}$  gives smaller compression ratios as indicated in Figure 5, with values of about 17 kΩ or less resulting in a compression ratio of 1:1. AGC performance is achieved with compression ratios between 2:1 and 15:1, and is dependent on the application. A 100 kΩ potentiometer may be used to allow this parameter to be adjusted. On the evaluation board (Figure 22), an optional resistor can be used to set the compression equal to 1:1 when the wiper of the potentiometer is at its full CCW position.

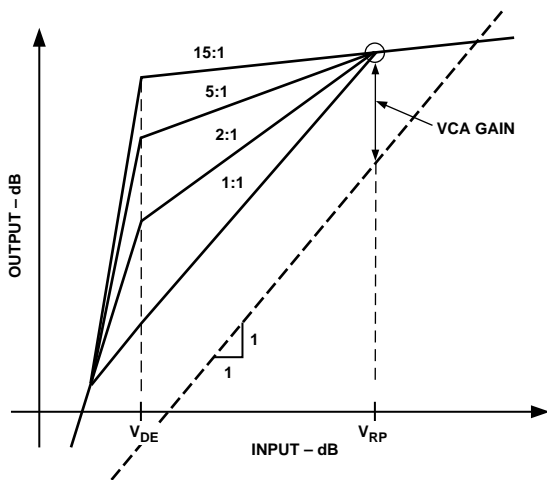

Figure 16. Effect of Varying the Compression Ratio

**Rotation Point.** An internal dc reference voltage in the control circuitry, used to set the rotation point, is user-specified, as illustrated in Figure 9. The effect on rotation point is shown in Figure 17. By varying a resistor,  $R_{ROT PT}$ , connected between the positive supply and the ROTATION POINT SET pin (Pin 11),

the rotation point may be varied from approximately 20 mV rms to 1 V rms. From the figure, the rotation point is inversely proportional to  $R_{ROT PT}$ . For example, a 1 kΩ resistor would typically set the rotation point at 1 V rms, whereas a 55 kΩ resistor would typically set the rotation point at approximately 30 mV rms.

Since limiting occurs for signals larger than the rotation point ( $V_{IN} > V_{RP}$ ), the rotation point effectively sets the maximum output signal level. It is recommended that the rotation point be set at the upper extreme of the range of typical input signals so that the compression region will cover the entire desired input signal range. Occasional larger signal transients will then be attenuated by the action of the limiter.

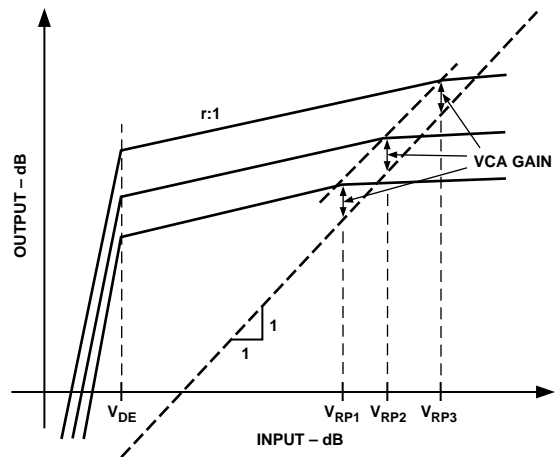

Figure 17. Effect of Varying the Rotation Point

**VCA Gain Setting and Muting.** The maximum gain of the SSM2166 is set by the GAIN ADJUST pin (Pin 2) via  $R_{GAIN}$ . This resistor, with a range between 1 kΩ and 20 kΩ, will cause the nominal VCA gain to vary from 0 dB to approximately 20 dB, respectively. To set the VCA gain to its maximum can also be achieved by leaving the GAIN ADJUST pin in an OPEN condition (no connect). Figure 18 illustrates the effect on the transfer characteristic by varying this parameter. For low level signal sources, the VCA should be set to maximum gain using a 20 kΩ resistor.

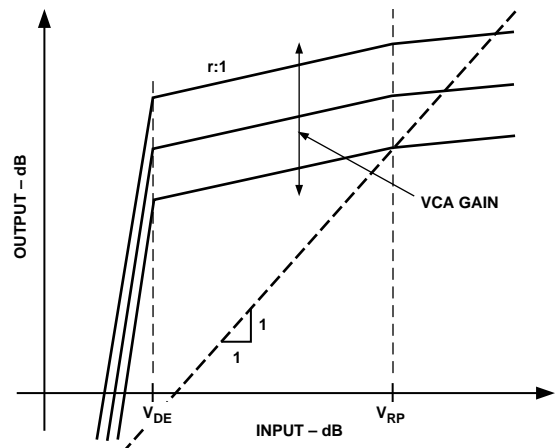

Figure 18. Effect of Varying the VCA Gain Setting

The gain of the VCA can be reduced below 0 dB by making  $R_{GAIN}$  smaller than 1 k $\Omega$ . Switching Pin 2 through 330  $\Omega$  or less to ground will mute the output. Either a switch connected to ground or a transistor may be used, as shown in Figure 19. To avoid audible “clicks” when using this MUTE feature, a capacitor (C5 in figure) can be connected from pin 2 to GND. The value of the capacitor is arbitrary and should be determined empirically, but a 0.01  $\mu$ F capacitor is a good starting value.

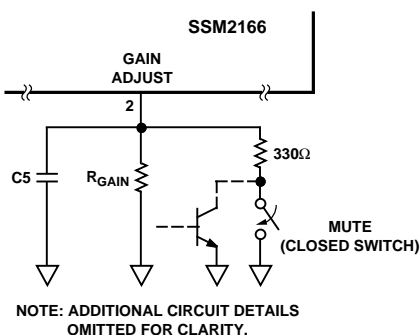

Figure 19. Details of SSM2166 Mute Option

**Downward Expansion Threshold.** The downward expansion, or noise gate, threshold is determined via a second reference voltage internal to the control circuitry. This second reference can be varied in the SSM2166 using a resistor,  $R_{GATE}$ , connected between the positive supply and the NOISE GATE SET pin (Pin 9) of the SSM2166. The effect of varying this threshold is shown in Figure 20. The downward expansion threshold may be set between 300  $\mu$ V rms and 20 mV rms by varying the resistance value between Pin 9 and the supply voltage. Like the ROTATION PT ADJUST, the downward expansion threshold is inversely proportional to the value of this resistance: setting this resistance to 1 M $\Omega$  sets the threshold at approximately 250  $\mu$ V rms, whereas a 10 k $\Omega$  resistance sets the threshold at approximately 20 mV rms. This relationship is illustrated in Figure 4. A potentiometer network is provided on the evaluation board for this adjustment. In general, the downward expansion threshold should be set at the lower extreme of the desired range of the input signals, so that signals below this level will be attenuated.

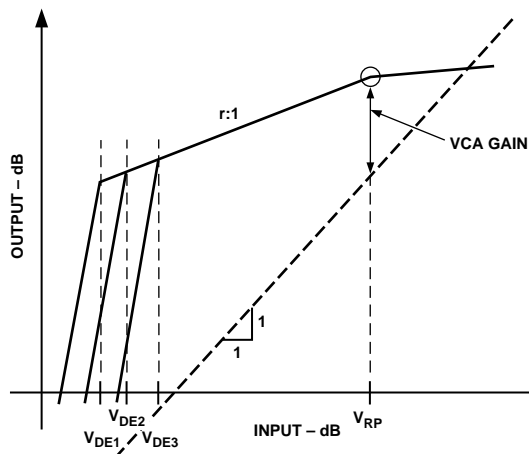

Figure 20. Effect of Varying the Downward Expansion (Noise Gate) Threshold

### Power-Down Feature

The supply current of the SSM2166 can be reduced to under 100  $\mu$ A by applying an active HIGH, 5 V CMOS compatible input to the SSM2166's POWER DOWN pin (Pin 12). In this state, the input and output circuitry of the SSM2166 will assume a high impedance state; as such, the potentials at the input pin and the output pin will be determined by the external circuitry connected to the SSM2166. The SSM2166 takes approximately 200 ms to settle from a POWER-DOWN to POWER-ON command. For POWER-ON to POWER-DOWN, the SSM2166 requires more time, typically less than 1 s. Cycling the power supply to the SSM2166 can result in quicker settling times: the off-to-on settling time of the SSM2166 is less than 200 ms, while the on-to-off settling time is less than 1 ms. In either implementation, transients may appear at the output of the device. In order to avoid these output transients, MUTE control of the VCA's gain as previously mentioned should be used.

### PC Board Layout Considerations

Since the SSM2166 is capable of wide bandwidth operation and can be configured for as much as 80 dB of gain, special care must be exercised in the layout of the PC board which contains the IC and its associated components. The following applications hints should be considered and/or followed:

- (1) In some high system gain applications, the shielding of input wires to minimize possible feedback from the output of the SSM2166 back to the input circuit may be necessary.
- (2) A single-point (“star”) ground implementation is recommended in addition to maintaining short lead lengths and PC board runs. The evaluation board layout shown in Figure 23 for the SSM2166 demonstrates the single-point grounding scheme. In applications where an analog ground and a digital ground are available, the SSM2166 and its surrounding circuitry should be connected to the system's analog ground. As a result of these recommendations, wire-wrap board connections and grounding implementations are to be explicitly avoided.
- (3) The internal buffer of the SSM2166 was designed to drive only the input of the internal VCA and its own feedback network. Stray capacitive loading to ground from the BUF<sub>OUT</sub> pin in excess of 5 pF to 10 pF can cause excessive phase shift and can lead to circuit instability.
- (4) When using high impedance sources ( $\geq 5$  k $\Omega$ ), system gains in excess of 60 dB are not recommended. This configuration is rarely appropriate, as virtually all high impedance inputs provide larger amplitude signals that do not require as much amplification. When using high impedance sources, however, it can be advantageous to shunt the source with a capacitor to ground at the input pin of the IC (Pin 7) to lower the source impedance at high frequencies, as shown in Figure 21. A capacitor with a value of 1000 pF is a good starting value and sets a low pass corner at 31 kHz for 5 k $\Omega$  sources. In those applications where the source ground is not as “clean” as would be desirable, a capacitor (illustrated as C7 on the evaluation board) from the VCA<sub>R</sub> input to the source ground might prove beneficial. This capacitor is used in addition to the grounded capacitor (illustrated as C2 on the evaluation board) used in the feedback around the buffer, assuming that the buffer is configured for gain.

# SSM2166

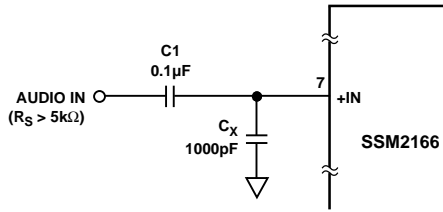

NOTE: ADDITIONAL CIRCUIT DETAILS OMITTED FOR CLARITY.

Figure 21. Circuit Configuration for Use with High Impedance Signal Sources

The value of the C7 should be the same as C6, the capacitor value used between BUF<sub>OUT</sub> and VCA<sub>IN</sub>. This connection makes the source ground noise appear as a common-mode signal to the VCA, allowing the common-mode noise to be rejected by the VCA's differential input circuitry. C7 can also be useful in reducing ground loop problems and in reducing noise coupling from the power supply by balancing the impedances connected to the inputs of the internal VCA.

## SSM2166 Evaluation Board

A schematic diagram of the SSM2166 evaluation board, available upon request from Analog Devices, is illustrated in Figure 22. As a design aid, the layouts for the topside silkscreen, topside and backside metallization layers are shown in Figures 23a, b, and c. Although not shown to scale, the finished dimension of the evaluation board is 3.5 inches by 3.5 inches, and comes complete with pin sockets and a sample of the SSM2166.

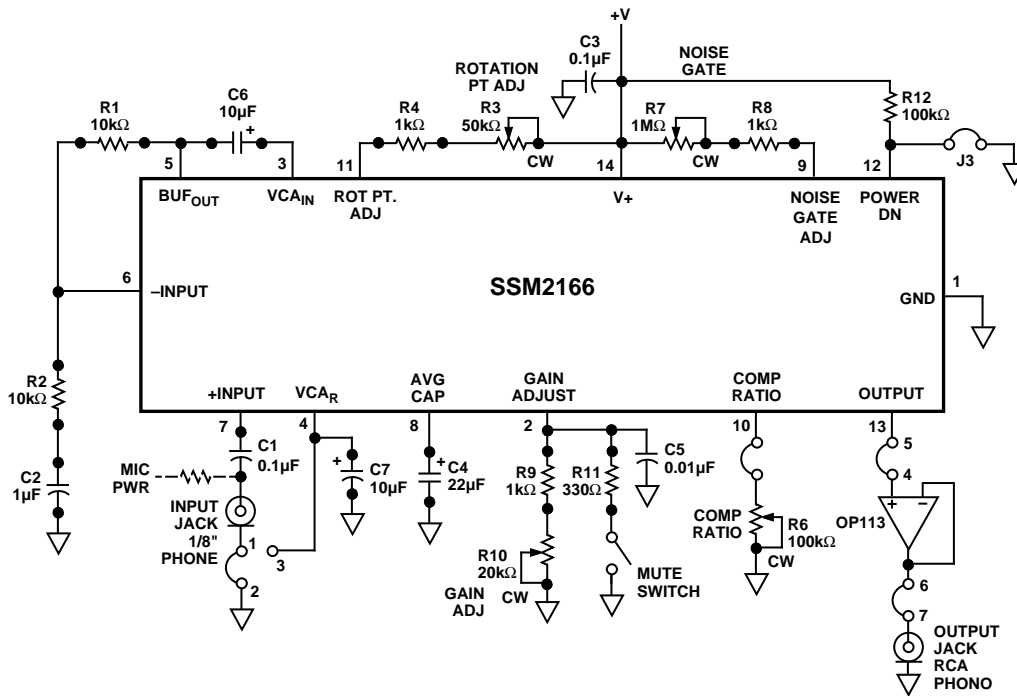

Figure 22. Evaluation Board

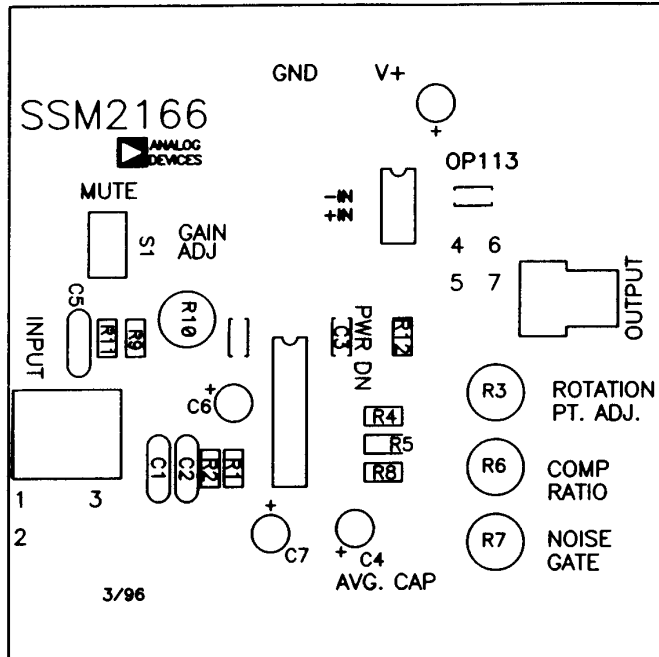

Figure 23a. Evaluation Board Topside Silkscreen (Not to Scale)

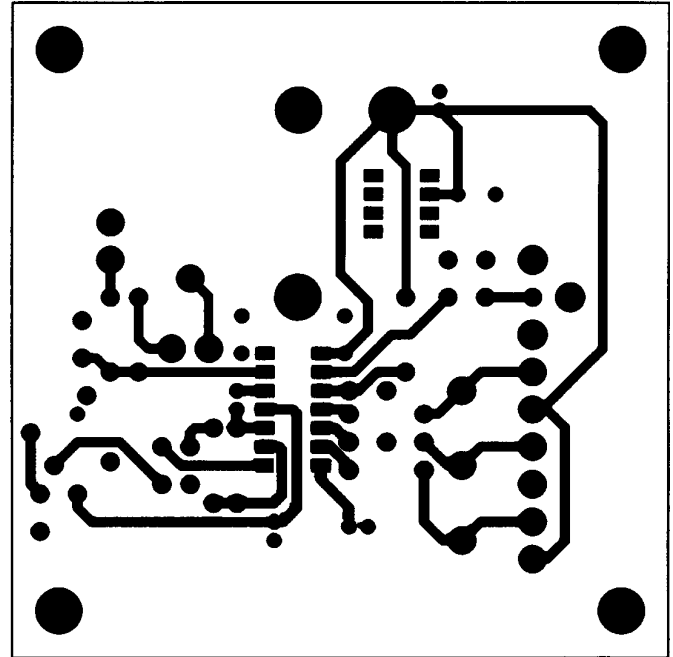

Figure 23c. Evaluation Board Backside Metallization (Not to Scale)

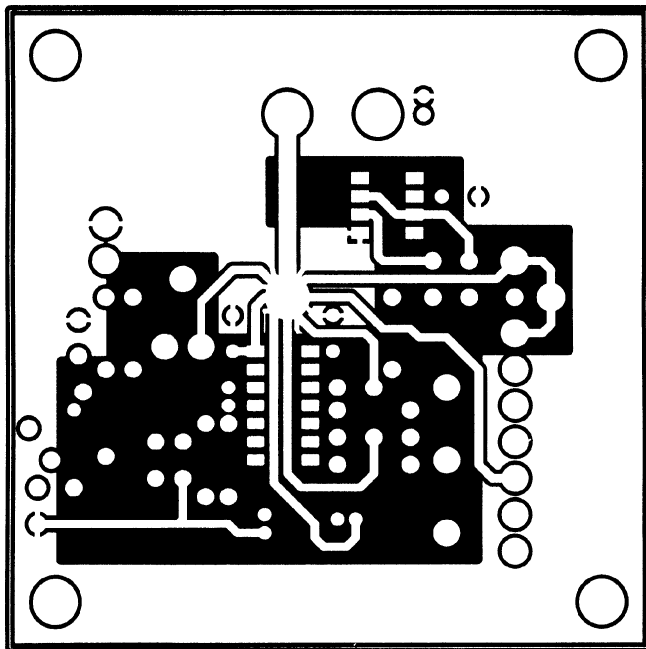

Figure 23b. Evaluation Board Topside Metallization (Not to Scale)

Signal sources are connected to the SSM2166 through a 1/8" phone jack where a 0.1  $\mu\text{F}$  capacitor couples the input signal to the SSM2166's +IN pin (Pin 7). As shown in Figure 22 and in microphone applications, the phone jack shield can be optionally connected to the board's ground plane (Jumper J1 inserted into board socket pins labeled "1" & "2") or to the SSM2166's  $\text{VCA}_R$  input at Pin 4 (Jumper J1 inserted into board socket pins labeled "1" & "3"). If the signal source is a waveform or function generator, the phone jack shield is to be connected to ground.

For ease in making adjustments for all of the SSM2166's configuration parameters, single-turn potentiometers are used throughout. Optional Jumper J2 connects the COMP RATIO pin to ground and sets the SSM2166 for no compression (that is, compression ratio = 1:1). Optional Jumper J3 connects the SSM2166's POWER DOWN input to ground for normal operation. Jumper J3 can be replaced by an open-drain logic buffer for a digitally-controlled shutdown function. An output signal MUTE function can be implemented on the SSM2166 by connecting the GAIN ADJUST pin (Pin 2) through a 330  $\Omega$  resistance to ground. This is provided on the evaluation board via R11 and S1. A capacitor C5, connected between Pin 2 and ground and provided on the evaluation board, can be used to avoid audible "clicks" when using the MUTE function.

To configure the SSM2166's input buffer for gain, provisions for R1, R2, and C2 have been included. To configure the input buffer for unity-gain operation, R1 and R2 are removed, and a direct connection is made between the -IN pin (Pin 6) and the  $\text{BUF}_{\text{OUT}}$  pin (Pin 5) of the SSM2166.

The output stage of the SSM2166 is capable of driving > 1 V rms (3 V p-p) into > 5 k $\Omega$  loads, and is externally available through an RCA phono jack provided on the board. If the output of the SSM2166 is required to drive a lower load resistance

# SSM2166

or an audio cable, then the onboard OP113 can be used. To use the OP113 buffer, insert Jumper J4 into board socket pins labeled “4” & “5” and insert Jumper J5 into board socket pins labeled “6” & “7.” If the output buffer is not required, remove Jumper J5 and insert Jumper J4 into board socket pins “5” & “7.” There are no blocking capacitors either on the input nor at the output of the buffer. As a result, the output dc level of the buffer will match the output dc level of the SSM2166, which is approximately 2.3 V. A dc blocking capacitor may be inserted on Pins 6 and 7. An evaluation board and setup procedure is available from your Analog Devices representative.

## Setup Procedure with Evaluation Board

To illustrate how easy it is to program the SSM2166, we will take a practical example. The SSM2166 will be used interface an electret-type microphone to a post-amplifier. You can use the evaluation board or the circuit configuration shown in Figure 22. The signal from the microphone was measured under actual conditions to vary from 1 mV to 15 mV. The post-amplifier requires no more than 500 mV at its input. The required gain from the SSM2166 is, therefore:

$$G_{TOT} = 20 \times \log(500/15) = 30 \text{ dB}$$

We will set the input buffer gain to 20 dB and adjust the VCA gain to 10 dB. The limiting or “rotation” point will be set at 500 mV output. From prior experience, we will start with a 2:1 compression ratio, and a noise gate threshold that operates below 100  $\mu$ V. These objectives are summarized in Figure 24, and we will fine-tune them later on. The transfer characteristic we will implement is illustrated in Figure 25.

INPUT RANGE	1-15 mV
OUTPUT RANGE	TO 500 mV
LIMITING LEVEL	500 mV
COMPRESSION	2:1
BUFFER GAIN	20 dB
VCA GAIN	10 dB
NOISE GATE	100 $\mu$ V

Figure 24. Objective Specifications

Note: the SSM2166 processes the output of the buffer, which in our example is 20 dB or ten times the input level. Use the oscilloscope to verify that you are not driving the buffer into clipping with excessive input signals. In your application, you should take the minimum gain in the buffer consistent with the average source level as well as the crest factor (ratio of peak to rms).

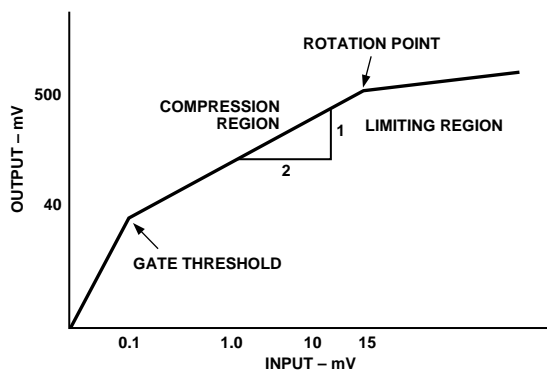

Figure 25. Transfer Characteristic

## Evaluation Board

If you build your own breadboard, keep the leads to Pins 3, 4, and 5 short. A convenient evaluation board is available from your sales representative. The R & C designations refer to the demonstration board schematic of Figure 22 and parts list, Figure 28.

## Test Equipment Setup

The recommended equipment and configuration is shown in Figure 26. A low noise audio generator with a smooth output adjustment range of 50  $\mu$ V to 50 mV is a suitable signal source. A 40 dB pad would be useful to reduce the level of most generators by 100X to simulate the microphone levels. The input voltmeter could be connected before the pad, and need only go down to 10 mV. The output voltmeter should go up to 2 volts. The oscilloscope is used to verify that the output is sinusoidal, that no clipping is occurring in the buffer, and to set the limiting and noise gating “knees.”

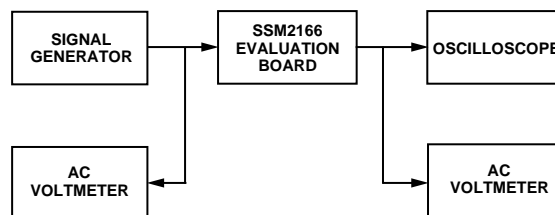

Figure 26. Test Equipment Setup

## STEP 1. Configure the Buffer

The SSM2166 has an input buffer that may be used when the overall gain required exceeds 20 dB, the maximum user-selectable gain of the VCA. In our example, the desired output is 500 mV for an input around 15 mV, requiring a total gain of 30 dB. We will set the buffer gain at 20 dB, and adjust VCA for 10 dB. In the socket pins provided on the evaluation board, Insert R1 = 100 k $\Omega$ , and R2 = 11 k $\Omega$ . You have set the buffer gain to 20 dB ( $\times 10$ ).

## STEP 2. Initialize Potentiometers

With power off, preset the potentiometers per the table of Figure 27 below.

FUNCTION	POT	RANGE	INITIAL POSITION	INITIAL RESISTANCE	EFFECT OF CHANGE
GAIN ADJUST (VCA)	R10	0-20 k $\Omega$	CCW	ZERO	0 dB; CW TO INCREASE VCA GAIN
ROTATION POINT	R3	0-50 k $\Omega$	CCW	ZERO	1 V; CW TO REDUCE ROTATION POINT
COMPRESSION RATIO	R6	0-100 k $\Omega$	CCW	ZERO	1:1; CW TO INCREASE COMPRESSION
NOISE GATE	R7	0-1 M $\Omega$	CW	1 M $\Omega$	300 $\mu$ V; CCW TO INCREASE THRESHOLD

Figure 27. Initial Potentiometer Settings

## STEP 3. Test Setup

With power on, adjust the generator for an input level of 15 mV, 1 kHz. The output meter should indicate approximately 100 mV. If not, check your setup.

## STEP 4. Adjusting the VCA Gain

Set the input level to 15 mV. Adjust R10—GAIN ADJ CW for an output level of 500 mV. You have now set the VCA gain to 10 dB.

**STEP 5. Adjusting the Rotation Point**

Set the input level to 15 mV, and observe the output on the oscilloscope. Adjust R3—ROTATION PT ADJ CW until the output level just begins to drop, then reverse so that the output is 500 mV. You have now set the limiting to 500 mV.

**STEP 6. Adjusting the Compression Ratio**

Set the input signal for an output of 500 mV but not in limiting. Note the value (around 15 mV). Next, reduce the input to 1/10 the value noted, (around 1.5 mV), for a change of -20 dB. Next, adjust R6—COMP RATIO CW until the output is 160 mV, for an output change of -10 dB. You have now set the compression, which is *the ratio of output change to input change, in dB, to 2:1*.

**STEP 7. Setting the Noise Gate**

With the input set at 100  $\mu$ V, observe the output on the oscilloscope, and adjust R7—ROT PT SET CCW until the output drops rapidly. "Rock" the control back and forth to find the "knee." You have set the noise gate to 100  $\mu$ V. The range of the noise gate is from 0.3 mV to over 0.5 mV relative to the output of the buffer. To fit this range to your application, you may have to attenuate the input or apportion the buffer gain and VCA gain differently.

**STEP 8. Listening**

At this time, you may want to connect an electret microphone to the SSM2166, and listen to the results. Be sure to include the proper power for the microphone's internal FET (usually +2 V to +5 V dc through a 2.2 k $\Omega$  resistor). Experiment with the settings to hear how the results change. Varying the averaging capacitor, C4, changes the attack and decay times, which are best determined empirically. Compression ratio will keep the output steady over a range of microphone to speaker distance, and the noise gate will keep the background sounds subdued.

**STEP 9. Record Values**

With the power removed from the test fixture, measure and record the values of all potentiometers, including any fixed resistance in series with them. If you have changed the averaging capacitor, C4, note its value too.

**SUMMARY**

We have implemented the transfer condition of Figure 2. For inputs below the 100  $\mu$ V noise gate threshold, circuit and background noise will be minimized. Above it, the output will increase at a rate of 1 dB for each 2 dB input increase, until the 500 mV rotation point is reached at an input of approximately 15 mV. For higher inputs that would drive the output beyond 500 mV, limiting will occur, and there will be little further increase. The SSM2166 processes the output of the buffer, which in our example is 20 dB or ten times the input level. Use the oscilloscope to ensure that you are not driving the buffer into clipping with the highest expected input peaks. Always take the minimum gain in the buffer consistent with the average source level and crest factor (ratio of peak to rms). The wide program range of the SSM2166 makes it useful in many applications other than microphone signal conditioning.

**Other Versions**

The SSM2165 is an 8-pin version of this microphone preamp with unity buffer gain and preset noise gate threshold. Customized parts are available for large volume users. For further information, contact your sales representative.

# SSM2166

## SSM2166 Demo Board Parts List

R1	10k*	Feedback
R2	10k	Input
R3	50k Pot	Rotation Point, Adj.
R4	1k	Rotation Point, Fixed
R5	0	Comp Ratio, Fixed
R6	100k Pot	Comp Ratio, Adj.
R7	1M Pot	Noise Gate, Adj.
R8	1k	Noise Gate, Fixed
R9	1k	Gain Adj., Fixed
R10	20k Pot	Gain Adj.
R11	330	Mute
R12	100k	Power Down Pull-Up
C1	0.1*	Input DC Block
C2	1	Buffer Low f g = 1
C3	10	+V Bypass
C4	2.2-22	Avg. Cap
C5	0.01	Mute Click Suppress
C6	10	Coupling
C7	10	VCA Noise/DC Balance
C8	0.1	+V Bypass
C9	0.1	+V Bypass
IC1	SSM2166P	Mic Preamp
IC2	OP113FP	Op Amp, Output Buffer
S1	SPST	Mute
J1	1/8" Mini Phone Plug	MIC Input
J2	RCA Female	Output Jack

\*Note: R values in k $\Omega$ , C values in  $\mu$ F.

Figure 28. Evaluation Board Parts List

**OUTLINE DIMENSIONS**

Dimensions shown in inches and (mm).

**14-Lead Plastic DIP  
(N-14)**

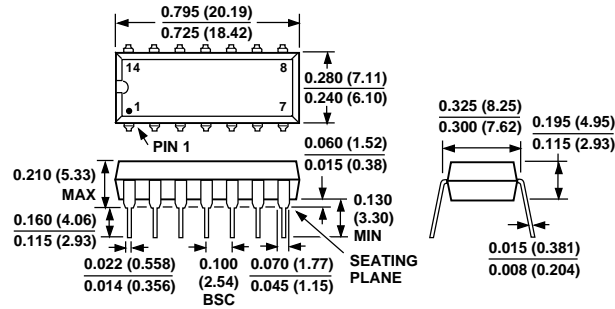

**14-Lead Narrow-Body SOIC  
(SO-14)**

